

1645070 风轮*1

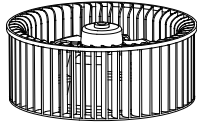

1645066 PTC组件*1

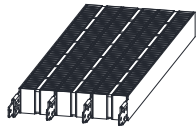

1645071 电机*1

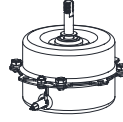

1645067 主控板*1

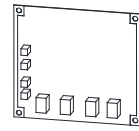

1645070 灯板驱动*1

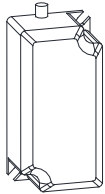

1645069 换气出风口*1

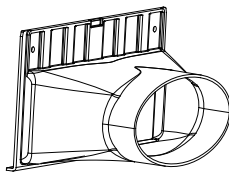

1582769 卡箍*2

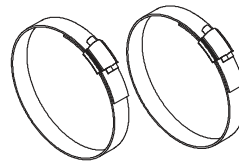

1582770 Φ100出风窗

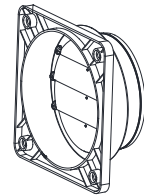

1322379吊杆配件*2 1553700加长吊杆配件*6

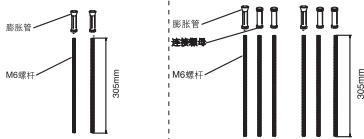

1322380 紧固组件*2

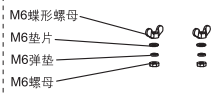

1645073 集成顶用安装配件包*1

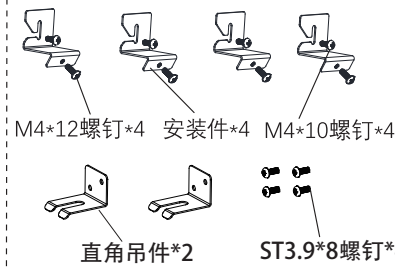

1645077石膏顶用安装配件包*1

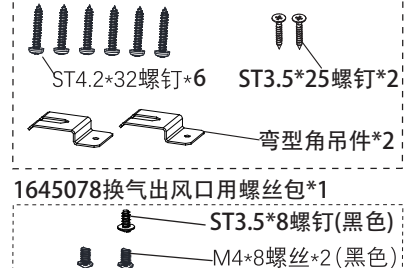

1645075 墙装遥控器组件*1

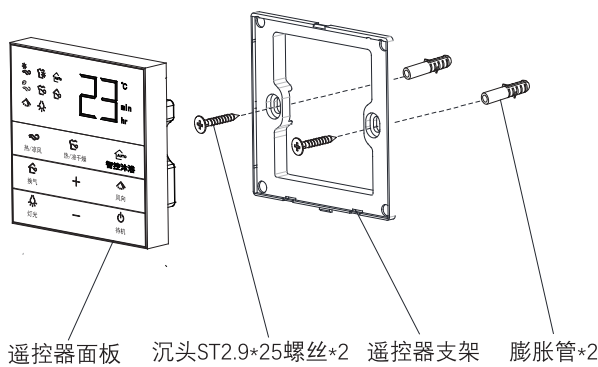
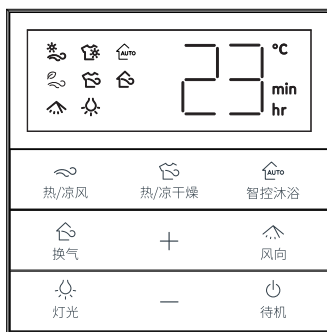

1582768 Φ100排风管*1



1645076 螺丝包*1

描述	单位	数量
ST3.5*10自攻螺丝(黑色)	pcs	24
ST3.5*9.5自攻螺丝	pcs	2
薄平头M4*10螺丝(黑色)	pcs	10
M4*8螺丝(黑色)	pcs	6
ST2.9*6自攻螺丝	pcs	4
ST2.9*16自攻螺丝	pcs	2
M4*16带垫组合机丝螺丝	pcs	4
M4螺母	pcs	9
M8螺母	pcs	1
M4*5螺柱	pcs	3